

FUZZY LOGIC CONTROL OF A QUADROTOR

Ming Li, University of Michigan-Flint

Abstract

Quadrotors have attracted considerable research interests because they are highly maneuverable. Quadrotors can achieve quasi-stationary flight as well as vertical take-off and landing, which enable them to be utilized for various applications such as surveillance and reconnaissance, search and rescue, environment monitoring and so on. However, since quadrotors are often utilized in complicated environments, damage to the structure of the quadrotors may occur; for example, the tip of the blades may be broken. In this study, the author developed a fuzzy logic controller to provide fault accommodations under different structural health conditions for quadrotors systems. The integration of health information and control strategies can optimize the performance of quadrotors. The proposed method was tested on the simulated model of the Draganflyer. The simulation results of the quadrotor operated under normal conditions and with component failure are presented here.

Introduction

Small four-rotor helicopters have gained popularity in unmanned aerial vehicle applications. They can achieve quasi-stationary hovering in addition to vertical take-off and landing (VTOL) in limited space. Unlike regular helicopters, they are under actuated dynamic vehicles with four fixed-pitch-angle rotors. The motion of a quadrotor is controlled by rotating the front and rear rotors counterclockwise and the left and right rotors clockwise. Using four rotors increases the payload capacity and maneuverability of the helicopter. But control of the system is very complicated, since all movements are highly dependent upon each other. Many studies have been carried out to optimize the control of quadrotors. Gao et al. [1] designed a fuzzy adaptive PD (proportional-derivative) controller for a quadrotor. Choi and Ahn [2] utilized a back-stepping-like feedback linearization method to control and stabilize a quadrotor. Li et al. [3] adopted time-optimal control by using a genetic algorithm.

In this paper, the author presents a fuzzy logic control system for the quadrotor under different health conditions. Fuzzy logic is based on the mathematical theory of fuzzy sets. It performs reasoning approximately rather than accurately with a series of if-then rules. With prior knowledge and experience turned into rules, fuzzy logic can simplify modeling and control of a complex nonlinear system reliably and efficiently. In several studies, fuzzy logic was ap-

plied in order to actively reconfigure the control scheme to maintain operations of the system when faults occur [4].

The approach in this current study was tested on the simulated model of the Draganflyer manufactured by RCToys [5], which is shown in Figure 1. With a structure assembled from low-cost components, the possibility of component failure may increase. It is necessary to identify and evaluate the health conditions of the system in order to optimize the control strategies of a quadrotor. In the proposed approach, the possible structural health conditions of a quadrotor were classified and the reconfiguration of the controller was automatically achieved so that stable and acceptable performance of the system could be maintained.



Figure 1. Draganflyer V Ti Quadrotor

Dynamic Model

The propulsion of the quadrotor comes from four electric motors. The lift forces vary with the rotor speed. The difference in the lift forces tilts the quadrotor and the quadrotor accelerates along that direction. By increasing/reducing the speed of the front rotor while at the same time reducing/increasing the speed of the rear rotor, the pitch movement can be obtained [6]. By changing the speed of the lateral rotors with a similar approach, the roll movement can be obtained. By varying the speed of the two pairs of rotors together, the yaw movement can be obtained. Figure 2 shows the simplified model of the quadrotor:

where, $I = \{e_x, e_y, e_z\}$ denotes the inertial frame attached to the earth; $A = \{e_1, e_2, e_3\}$ is a body fixed frame attached at

the center of mass of the quadrotor; and ϕ , θ , ψ are Euler angles, which denote roll, pitch, and yaw, respectively.

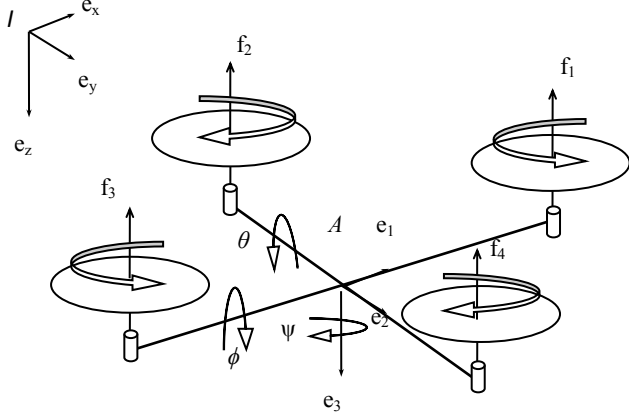

Figure 2. Schematic Diagram of the Quadrotor

The dynamic model of the helicopter was derived using Equations (1)-(5) [6], [7]:

$$\dot{\xi} = v \quad (1)$$

$$\dot{v} = g e_z - \frac{1}{m} T R e_z \quad (2)$$

$$\dot{R} = R s k (\Omega) \quad (3)$$

$$I_f \dot{\Omega} = -\Omega \times I_f \Omega - G_a + \tau_a \quad (4)$$

$$I_r \dot{\omega}_i = \tau_i - Q_i \quad (5)$$

where, $\xi = [x \ y \ z]^T$ and $v = [v_x \ v_y \ v_z]^T$ denote the position and velocity of the origin of A with respect to I , respectively.

Equations (6) and (7) give the total thrust, T , and the rotational transformation matrix, R :

$$T = \sum_{i=1}^4 |f_i| \quad (6)$$

$$R = \begin{bmatrix} C_\theta C_\psi & C_\psi S_\theta S_\phi - S_\psi C_\theta & C_\psi S_\theta C_\phi + S_\psi S_\theta \\ C_\theta S_\psi & S_\psi S_\theta S_\phi + C_\psi C_\theta & S_\psi S_\theta C_\phi - C_\psi S_\theta \\ -S_\theta & S_\phi C_\theta & C_\phi C_\theta \end{bmatrix} \quad (7)$$

And, $\Omega = \{\Omega_1, \Omega_2, \Omega_3\}^T$ denotes the angular velocity expressed in A , and I_f is the inertia matrix around the center of mass. Equation (8) gives the gyroscopic torque, G_a , and Equations (9)-(11) give each component of the torque:

$$G_a = \sum_{i=1}^4 I_r (\Omega \times e_z) (-1)^{i+1} \omega_i \quad (8)$$

$$\tau_a^1 = db (\omega_2^2 - \omega_4^2) \quad (9)$$

$$\tau_a^2 = db (\omega_1^2 - \omega_3^2) \quad (10)$$

$$\tau_a^3 = k (\omega_1^2 + \omega_3^2 - \omega_2^2 - \omega_4^2) \quad (11)$$

where, $\tau_a = [\tau_a^1, \tau_a^2, \tau_a^3]^T$ denotes the airframe torques; k and b are proportional parameters that depend on the density of the air, the properties of the rotor blades, and other factors; d is the distance from the rotors to the center of mass of the quadrotor; ω_i denotes the angular velocity of the rotor i ; and, I_r is the moment of inertia of a rotor around its axis.

Fuzzy Logic Controller

As for flight guidance of UAVs, control systems are usually programmed to follow a planned path to reach to targets. However, as flight situations, health conditions, and other factors may vary during a mission, it is necessary that control systems adjust with the information from structural health monitoring in order to optimize the performance of the UAVs. Figure 3 shows the aforementioned control system using the integrated information of flight path and flight conditions simultaneously then determines the appropriate control strategies [8]. Flight conditions are mainly rotor performance and structural health integrity.

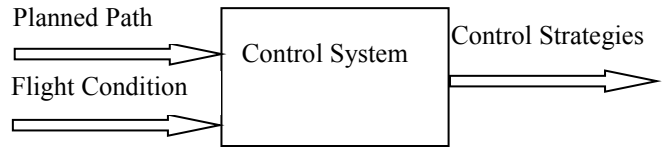

Figure 3. A Control System Integrated with Flight Conditions

In this current study, the flight condition and structural integrity were simulated and inputted to the control system. The fuzzy logic controller determined whether or not to continue a mission in case of component failures. Fuzzy logic is a fine choice for providing fault-tolerant control of the system. The set of rules can reconfigure the control parameters according to the health condition of the system. Figure 4 illustrates the Simulink model [9] implementing

the proposed approach. In this model, the flight condition is utilized to determine the health integrity of the system. The simulated condition of the rotors was evaluated with a health index, which was an input to the fuzzy logic controller. In this study, the given height was considered as the target of the mission. The fuzzy logic controller used the integrated information of targeted height as well as health index to guide the quadrotor to the target. It reconfigured the control surface as faults occurred; for example, if one or two rotors failed during the mission.

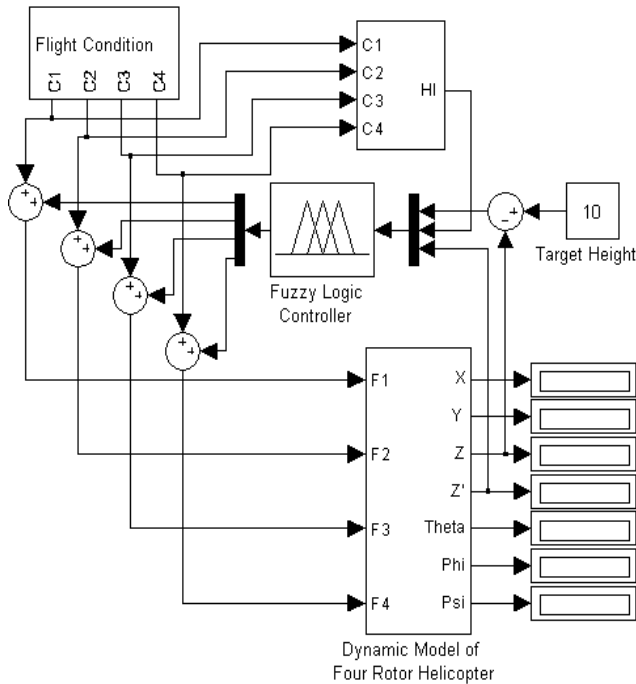

Figure 4. Simulink Model of the Fuzzy Logic Control System

Results and Discussion

The input variables of the fuzzy logic controller were offset to the targeted height, vertical speed, and health index. Figure 5 shows the membership functions of the height offset, which is the difference of the current height to the targeted height. The membership functions represent when the quadrotor is close-up, mid-range, and far away from the targeted height. Figure 6 shows the membership functions of the speed settings, according to the offset height. If the quadrotor is close to the targeted height, the speed is low; if it is far away from the target, the speed should be high. Thus, based on the height offset and the speed of the quadrotor, the controller was designed to drive the offset to zero. At the same time, if the health condition changed as one or two rotors failed, the controller had to reconfigure the control strategies of the rotors.

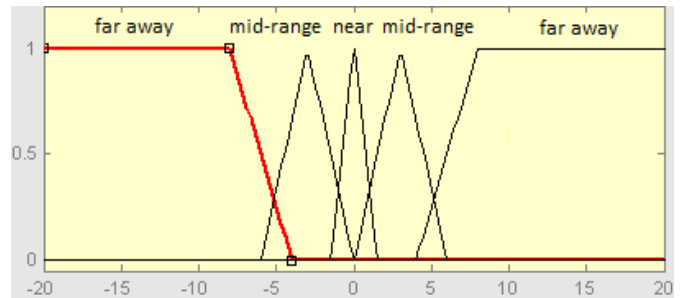

Figure 5. Membership Functions of Height Offset

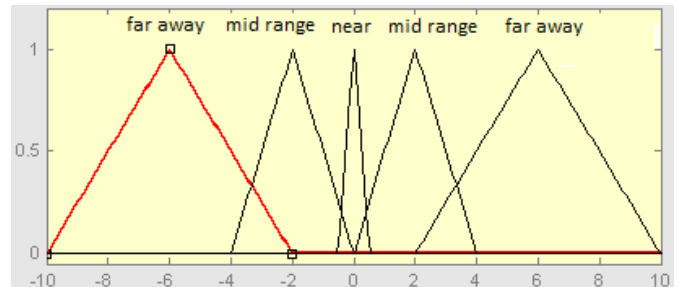

Figure 6. Membership Functions of Vertical Speed

The output of the fuzzy logic controller was the lift force of each rotor. The lift force is given by Equation (12):

$$f_i = -b\omega_i^2 e_s \quad (12)$$

where, ω_i is the rotating speed of rotor i , which can vary with the applied voltage.

Membership functions of the output forces are presented in Figure 7, and 150 if-then rules were designed to determine the driving forces, according to the height offset, speed, and health index. Figure 8 shows the set of rules utilized by the fuzzy logic controller. Membership functions and rules need fine tuning to make the control parameters converge.

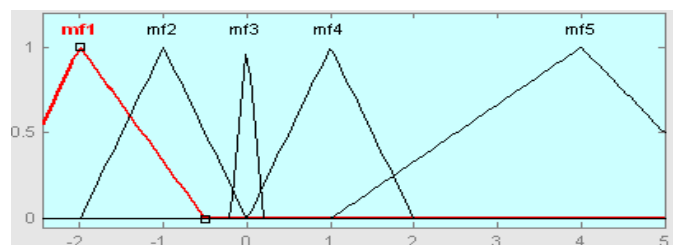

Figure 7. Membership Functions of Output Forces

Figure 9 shows the results of the quadrotor reaching the targeted height from the origin. It assumed that the health condition was perfect. As indicated from the graph, the helicopter climbed to the target under control of the fuzzy logic

controller; after a quick overshoot, it converged at the target height. The fuzzy logic controller also can provide fault accommodations when components fail. Figure 10 shows the simulation results when a fault occurred. The rotor labeled 1st failed at eight seconds. After the fault was identified, the health index was inputted to the controller. Based on the rules of the fuzzy logic controller, the output force for each rotor was reconfigured. From the graph, the quadrotor dropped first after the rotor failed. After the reconfiguration, the quadrotor climbed again and reached the target.

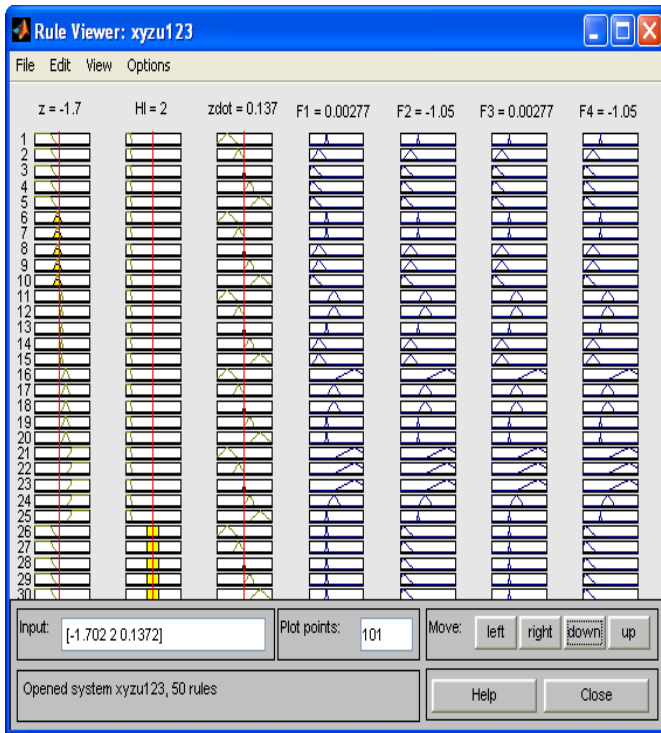

Figure 8. Rule Viewer

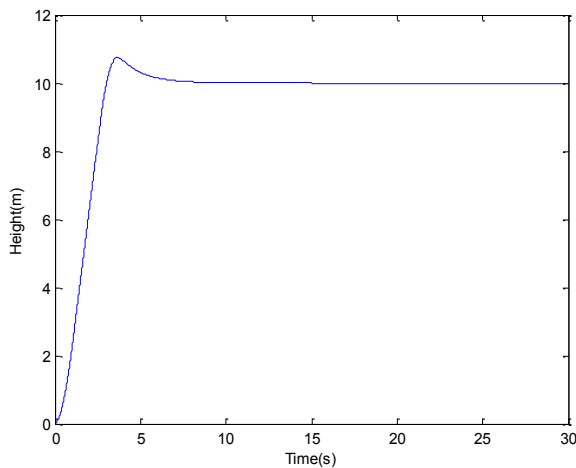

Figure 9. Simulink Result with No Fault

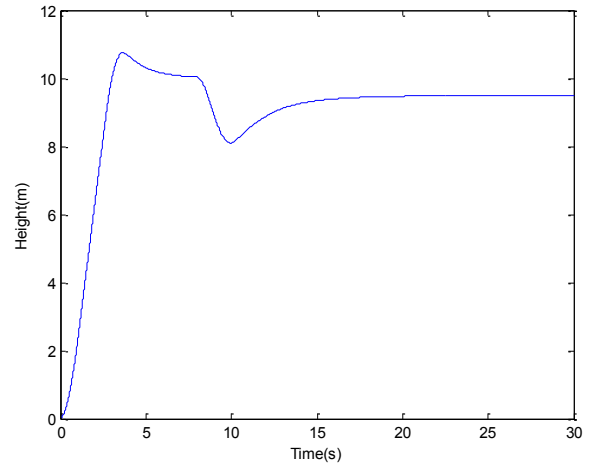

Figure 10. Simulink Result with Fault Occurred

Conclusion

The goal of this study was to bring and keep the quadrotor to the desired vertical coordinate, z . In this study, a fuzzy logic controller was designed to provide fault accommodation under different health conditions of a quadrotor. Fuzzy logic is a fine choice for fault tolerant control. It is convenient to program and powerful in the reconfiguration of flight management, considering the health condition of the components. The initial setup of the fuzzy logic controller for the proposed application was simple. However, membership functions and rules needed fine tuning in order to optimize the control parameters. It is a tedious trial-and-error process. The number of rules increased dramatically when the identified fault modes were increased, which increased computation time. If a central microcontroller monitors all sensors, the efficiency of the control strategies would suffer with the increase of the fault modes. Multiple fuzzy logic controllers can be designed to run in parallel to increase the computational speed.

References

- [1] Gao, H., Liu, C., Guo, D., & Liu, J. (2015). Fuzzy Adaptive PD Control for Quadrotor Helicopter. *Cyber Technology in Automation, Control, and Intelligent Systems (CYBER), 2015 IEEE International Conference*, (pp. 281-286). Shenyang, China.
- [2] Choi, Y. C., & Ahn, H. S. (2015). Nonlinear Control of Quadrotor for Point Tracking: Actual Implementation and Experimental Tests. *IEEE/ASME Transactions on Mechatronics*, 20(3), 1179-1192.
- [3] Li, C. L., Yang, C. C., & Wu, C. J. (2006). Time-Optimal Control of a Hovering Quadrotor Helicopter.

-
- Journal of Intelligent and Robotic Systems*, 45, 115-135.
- [4] Gao, Z., Ding, S. X., & Cecati, C. (2015). Real-Time Fault Diagnosis and Fault-Tolerant Control., *IEEE Transactions on Industrial Electronics*, 62(6), 3752-3756.
- [5] Draganflyer V Ti PRO RC Gyro Stabilized Electric Helicopter. (n.d.). Retrieved November 7, 2015, from <http://www.rctoys.com/rc-toys-and-parts/DF-VTI/RC-HELICOPTERS.html>.
- [6] Erginer, B., & Altuğ, E. (2007). Modeling and PD Control of a Quadrotor VTOL Vehicle. *Intelligent Vehicles Symposium, 2007 IEEE*, (pp. 894-899). Istanbul, Turkey.
- [7] Tayebi, A., & McGilvray, S. (2006). Attitude Stabilization of a VTOL Quadrotor Aircraft. *IEEE Transactions on Systems Technology*, 14(3), 562-571.
- [8] Bickraj, K., Pamphile, T., Yenilmez, A., Li, M., & Tansel, I. N. (2006). *Fuzzy Logic Based Integrated Controller for Unmanned Aerial Vehicles*. Paper presented at the Florida Conference on Recent Advances in Robotics (FCRAR 2006), Miami, Florida.
- [9] Li, M., Demetgul, M., Li, X. H., Lago, H., & Tansel, I. N. (2009). *Fault Tolerant Fuzzy Logic Control for Four Rotor Helicopter*. Paper presented at the Florida Conference on Recent Advances in Robotics (FCRAR 2009), Jupiter, Florida.

Biographies

MING LI is an assistant professor in the Department of Computer Science, Engineering and Physics at the University of Michigan-Flint. Dr. Li earned her Ph.D. in Mechanical and Materials Engineering from Florida International University in 2010. Her research interests include mechatronics, structural health monitoring, and robotics. Dr. Li may be reached at mingli@umflint.edu